

◆ DESCRIPTION

These miniature surface mount MOSFETs utilize High Cell Density process. Low $R_{DS(on)}$ assures minimal power loss and conserves energy, making this device ideal for use in power management circuitry.

Typical applications are PWM DC-DC converters, power management in portable and battery-powered products such as computers, printers, battery charger, telecommunication power system, and telephones power system.

◆ FEATURES

- 60V/4.5A, $R_{DS(ON)} = 58m\Omega @ V_{GS} = 10V$
- 60V/4.0A, $R_{DS(ON)} = 85m\Omega @ V_{GS} = 4.5V$
- -60V/-3.5A, $R_{DS(ON)} = 90m\Omega @ V_{GS} = -10V$
- -60V/-3.0A, $R_{DS(ON)} = 135m\Omega @ V_{GS} = -4.5V$
- Fast switching speed
- SOP-8 & TO-252 package design

◆ APPLICATIONS

- Power Management in Note
- Portable Equipment
- Battery Powered System
- Load Switch
- LCD Display inverter

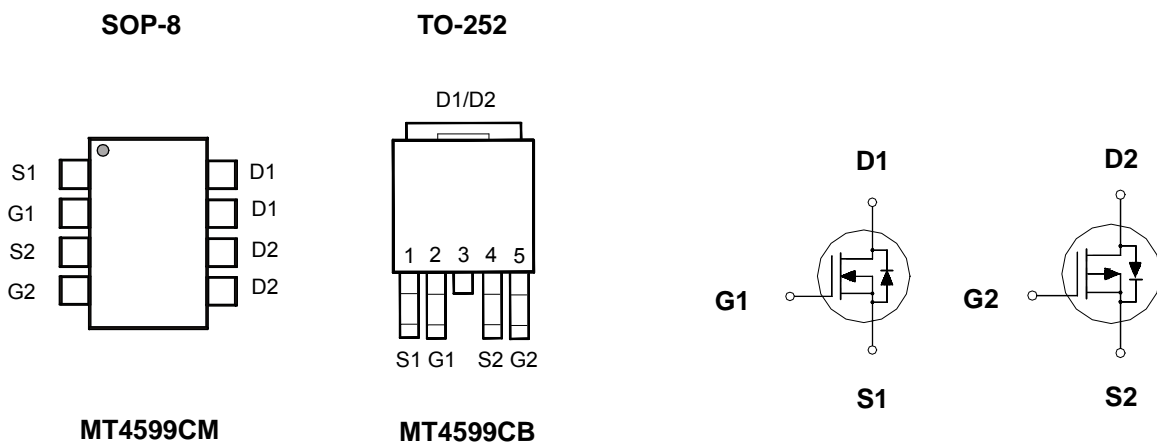
◆ PIN CONFIGURATION

◆ ABSOLUTE MAXIMUM RATINGS

 (T_A=25 °C Unless Otherwise Noted)

Parameter		Symbol	N-Channel	P-Channel	Unit
Drain-Source Voltage		V _{DS}	60	-60	V
Gate-Source Voltage		V _{GS}	20	-20	V
Continuous Drain Current ^a	T _A =25 °C	I _D	4.5	-3.5	A
	T _A =70 °C		4	-3	
Pulsed Drain Current ^b		I _{DM}	20	-20	A
Continuous Source Current (Diode Conduction) ^a		I _S	1.3	-1.3	A
Power Dissipation ^a	T _A =25 °C	P _D	2	2	W
	T _A =70 °C		1.3	1.3	
Operating Junction and Storage Temperature Range		T _J , T _{STG}	-55 to 150		°C

◆ THERMAL RESISTANCE RATINGS

Thermal Resistance		Symbol	Maximum	Unit
Maximum Junction-to-Ambient ^a	t ≤ 10sec(SOP-8)	R _{θJA}	62.5	°C/W
	Steady-State(SOP-8)		110	
	Steady-State(TO-252)		50	
Maximum Junction-to-Case	Steady-State (SOP-8)	R _{θJC}	40	°C/W
	Steady-State(TO-252)		6	

Note :

- a. Surface Mounted on 1" x 1" FR4 Board.
- b. Pulse width limited by maximum junction temperature

◆ ORDERING INFORMATION

Device	Package	Shipping
MT4599CM	SOP-8	2,500 Units/ Tape & Reel
MT4599CM	SOP-8	100 Units/ Tube
MT4599CB	TO-252	2,500 Units/ Tape & Reel

◆ ELECTRICAL CHARACTERISTICS

 (T_A=25 °C Unless Otherwise Noted)

Parameter	Symbol	Test Conditions	Limits				Unit
			Ch	Min	Typ	Max	
Static							
Gate-Threshold Voltage	V _{GS(th)}	V _{GS} = V _{DS} , I _D = 250 uA	N	1	1.5	2.5	V
		V _{GS} = V _{DS} , I _D = -250 uA	P	-1	-1.5	-2.5	
Gate-Body Leakage	I _{GSS}	V _{GS} = -20 V, V _{DS} = 0 V	P	-	-	±100	nA
		V _{GS} = 20 V, V _{DS} = 0 V	N	-	-	±100	
Zero Gate Voltage Drain Current	I _{DSS}	V _{DS} = -48 V, V _{GS} = 0 V	P	-	-	-1	uA
		V _{DS} = 48 V, V _{GS} = 0 V	N	-	-	1	
On-State Drain Current ^A	I _{D(on)}	V _{DS} = 5 V, V _{GS} = 10 V	N	20	-	-	A
		V _{DS} = -5 V, V _{GS} = -10 V	P	-20	-	-	
Drain-Source On-Resistance ^A	R _{DS(on)}	V _{GS} = 10 V, I _D = 4.5 A	N	-	40	58	mΩ
		V _{GS} = 4.5 V, I _D = 4 A		-	55	85	
		V _{GS} = -10 V, I _D = -3.5 A	P	-	70	90	
		V _{GS} = -4.5 V, I _D = -3 A		-	100	135	
Forward Transconductance ^A	g _{fs}	V _{DS} = 10 V, I _D = 4.5 A	N	-	14	-	S
		V _{DS} = -5 V, I _D = -3.5 A	P	-	9	-	
Dynamic							
Total Gate Charge	Q _g	N-Channel V _{DS} =0.5V, V _{GS} =10V, I _D =4.5A P-Channel V _{DS} =-0.5V, V _{GS} =-10V, I _D =-3.5A	N	-	12	-	nC
Gate-Source Charge	Q _{gs}		P	-	11	-	
			N	-	2.4	-	
Gate-Drain Charge	Q _{gd}		P	-	2.1	-	
			N	-	2.6	-	
Turn-On Delay Time	t _{d(on)}		P	-	2.5	-	
		N	-	11	-		
Rise Time	t _r	N	-	6	-	nS	
		P	-	8	-		
Turn-Off Delay Time	t _{d(off)}	N	-	8	-		
		P	-	8	-		
Fall-Time	t _f	N	-	19	-		
		P	-	17	-		
		N	-	6	-		
		P	-	11	-		

Note :

A . Pulse test: PW<=300us duty cycle <=2%

◆ **TYPICAL CHARACTERISTICS (N-Channel)**

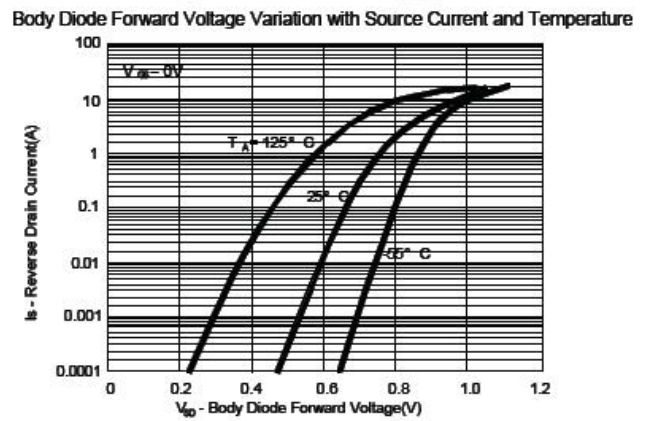
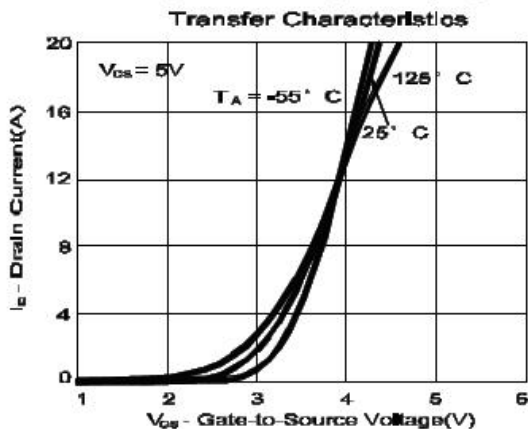
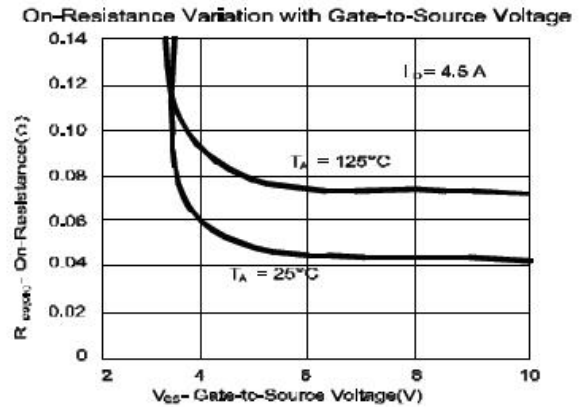
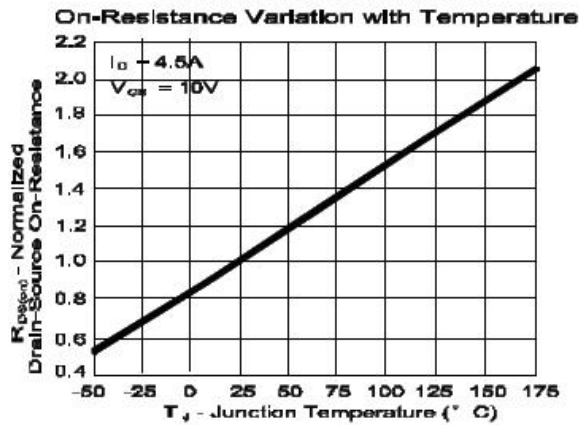
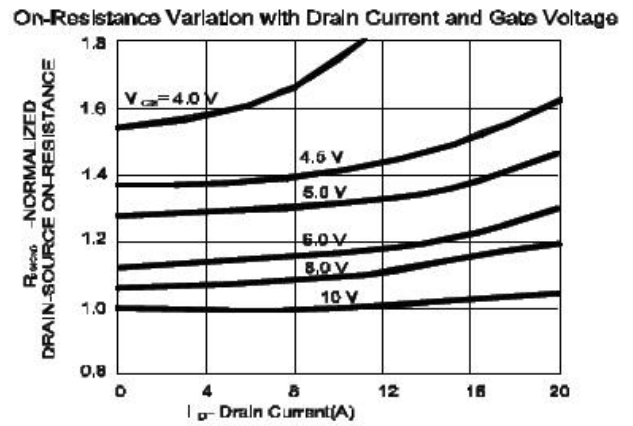
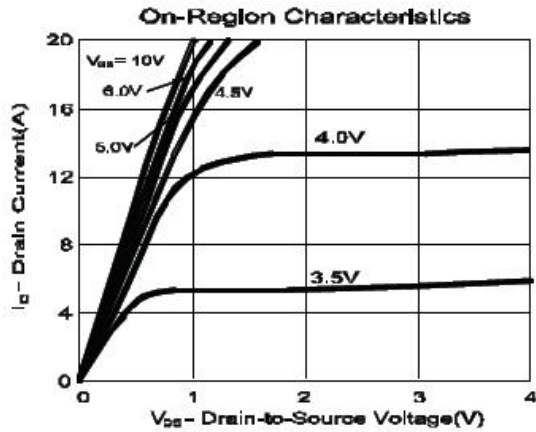

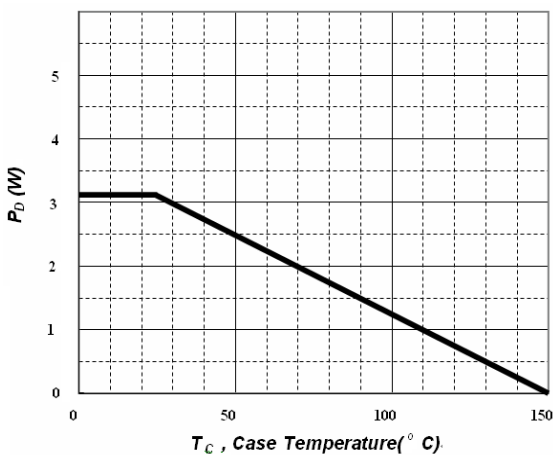
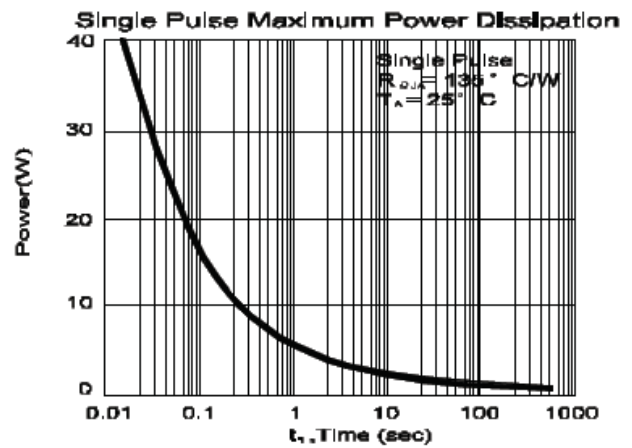
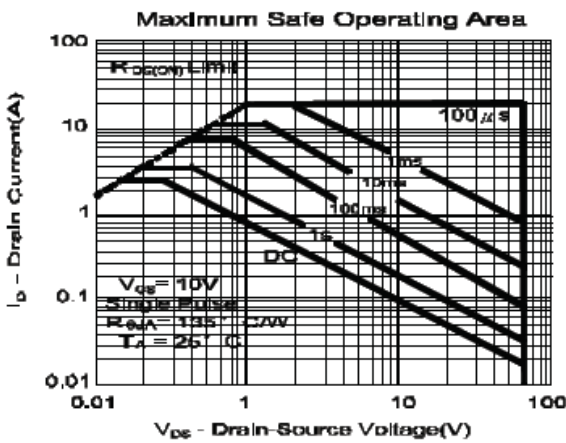
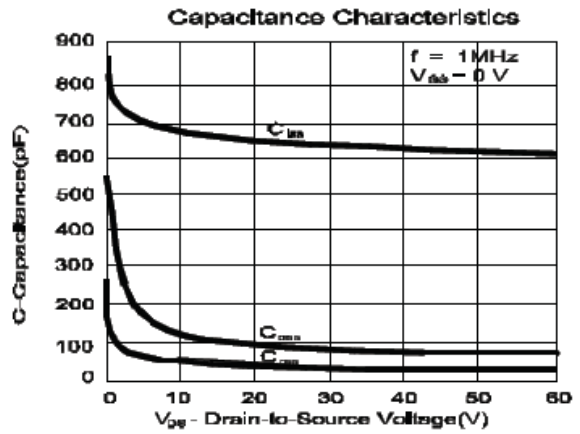
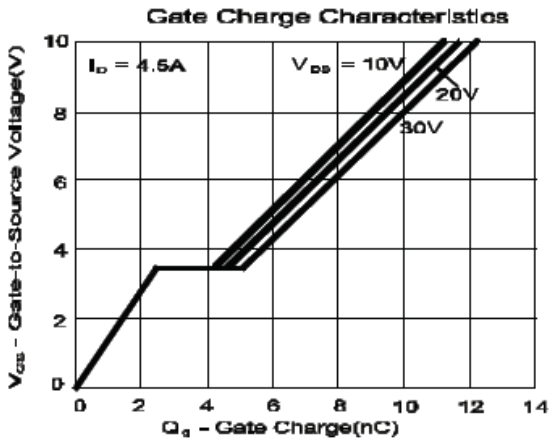
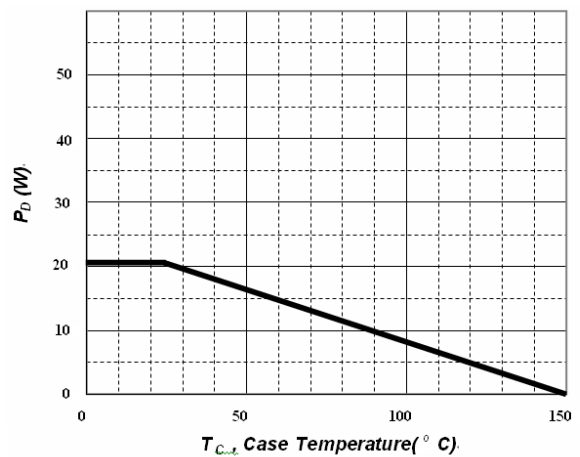
◆ TYPICAL CHARACTERISTICS (N-Channel)

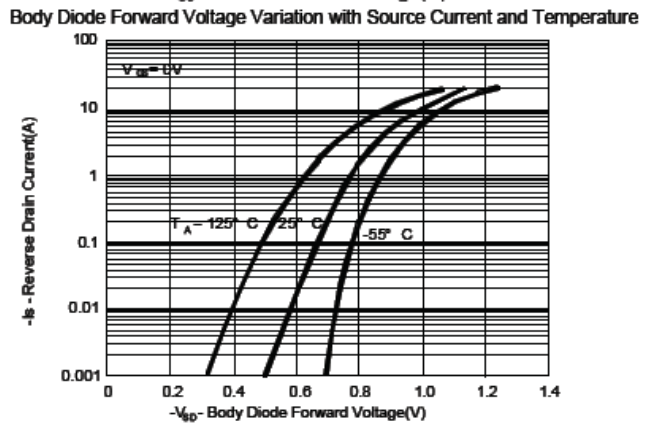
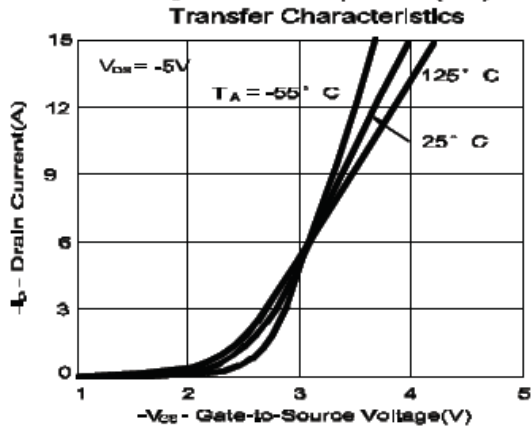
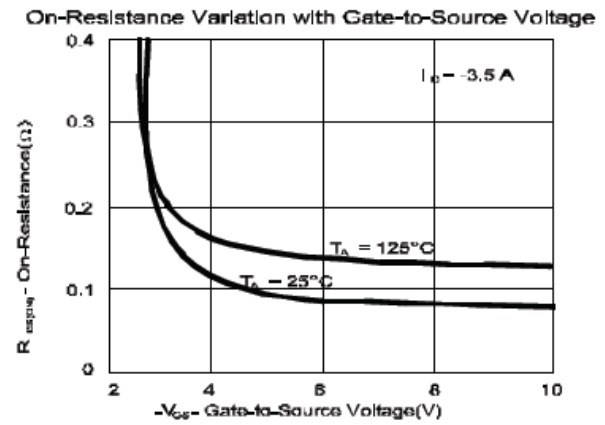
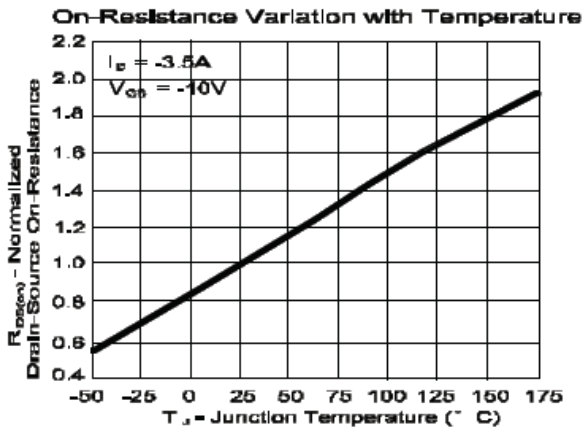
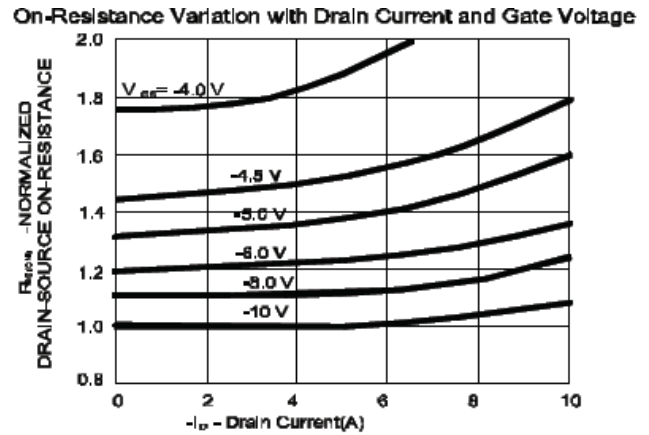
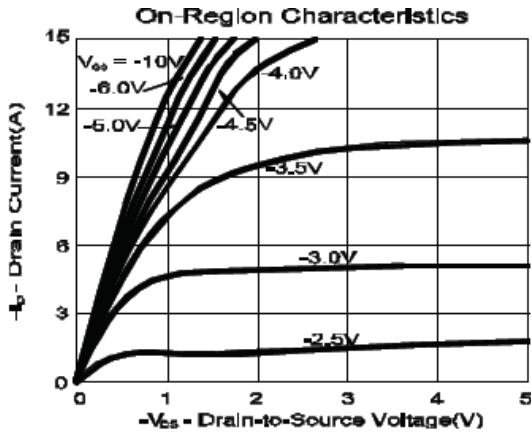
 SOP-8 package N-channel Power Dissipation (P_D vs. T_C)

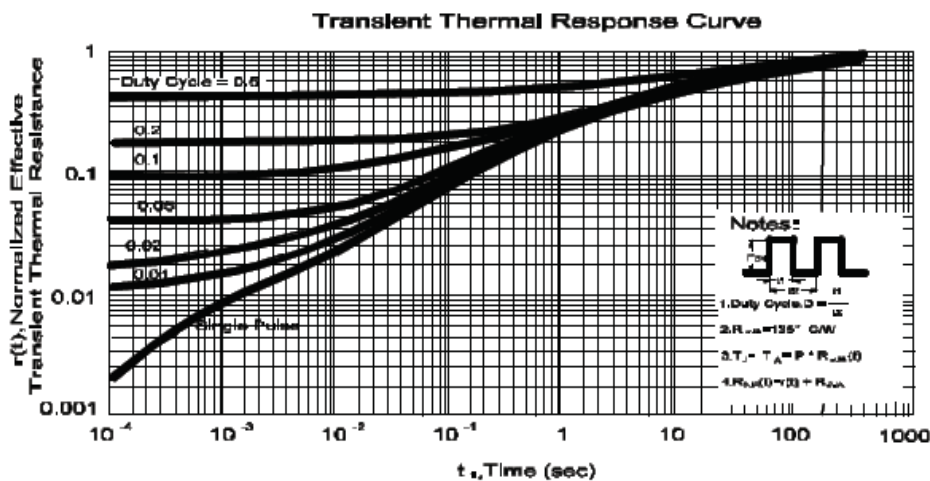
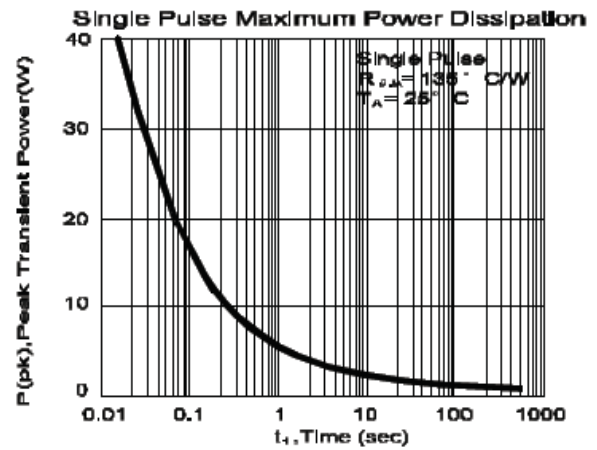
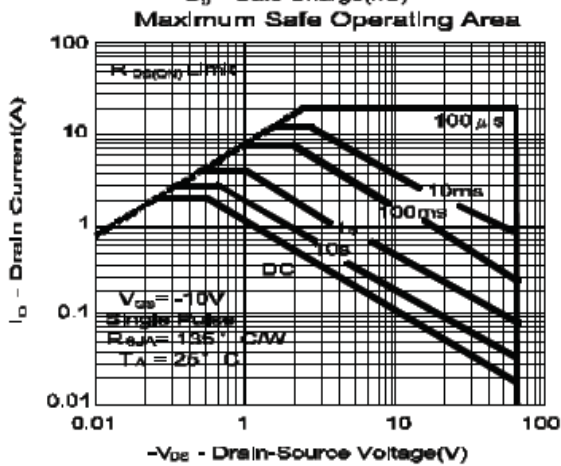
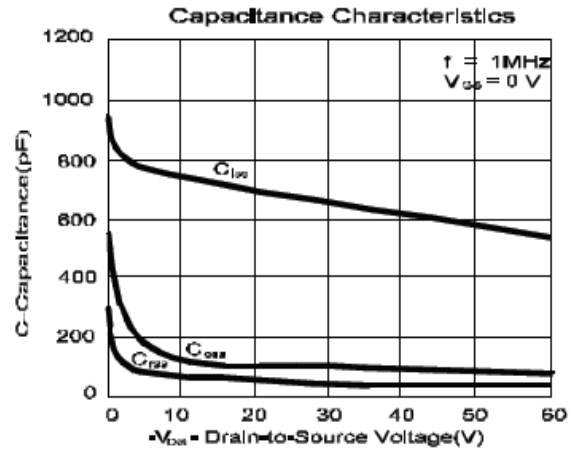
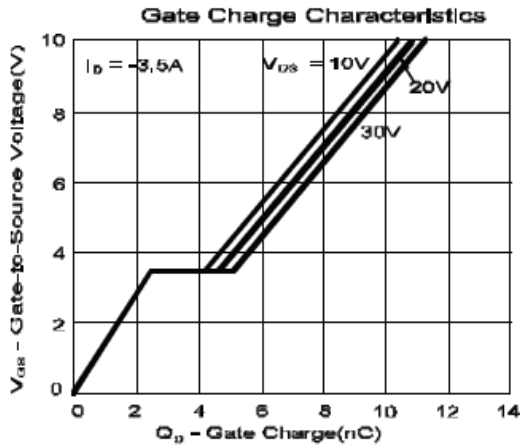
 TO-252 package N-channel Power Dissipation (P_D vs. T_C)

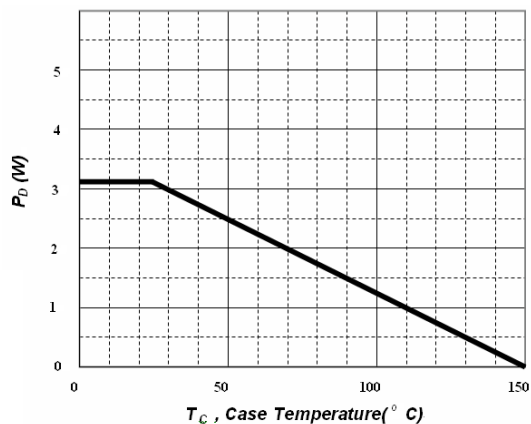
◆ TYPICAL CHARACTERISTICS (P-Channel)

◆ TYPICAL CHARACTERISTICS (P-Channel)

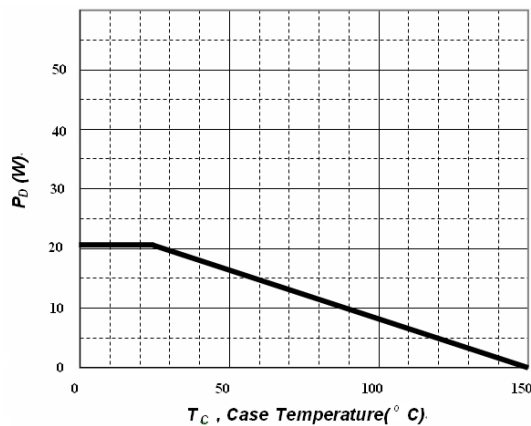
◆ TYPICAL CHARACTERISTICS (P-Channel)

SOP-8 package P-channel Power Dissipation (P_D vs. T_C)

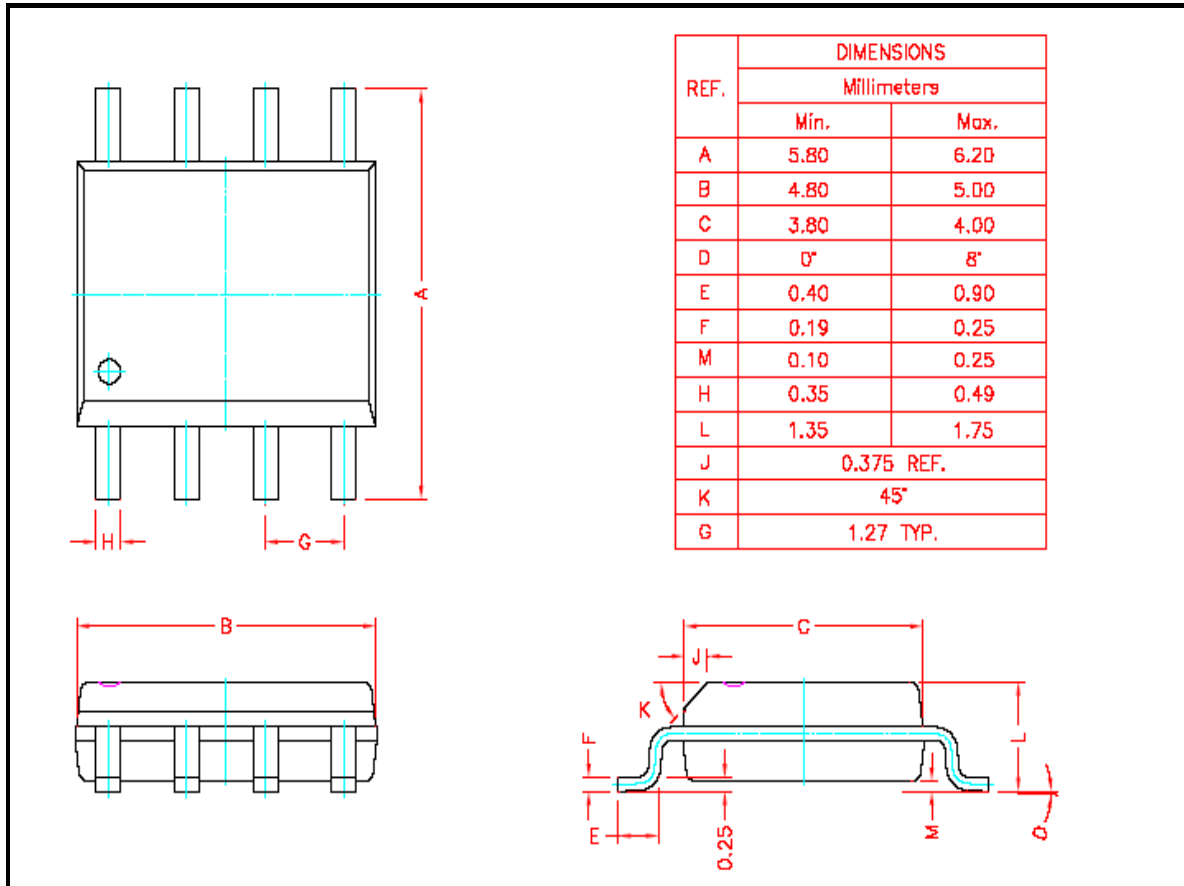

TO-252 package P-channel Power Dissipation (P_D vs. T_C)

◆ PHYSICAL DIMENSIONS
8-Pin Plastic S.O.I.C.

◆ PHYSICAL DIMENSIONS
5-Pin Plastic TO-252(DPAK)

Dimension	mm			Dimension	mm		
	Min.	Typ.	Max.		Min.	Typ.	Max.
A	9.0		10.4	J	4.8		5.46
B	2.1	2.3	2.5	L	0.44		0.68
C	0.4	0.5	0.6	M	1.1	1.3	1.5
E		0.508		S	5.2		5.515
F			0.3	T	4.4		5.004
G	5.3		6.223	U	1.4	1.52	1.77
H	0.89		1.7	V	0.9	1.2	1.5
I	6.3		6.731				

